



EGEDAL 2 LITTER BIN

Design: VE2

40, 80 or 105 litres with single or double side opening
Casing available smooth or with cut-out in your own design
Side-hinged hatch with bag holder for easy emptying
Front panel provides space for waste-sorting pictograms



EGEDAL 2

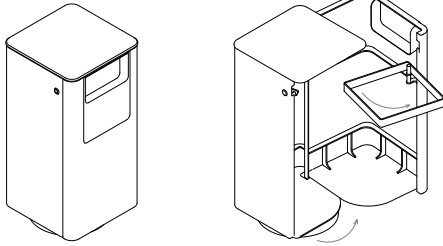

EGEDAL 2 40L

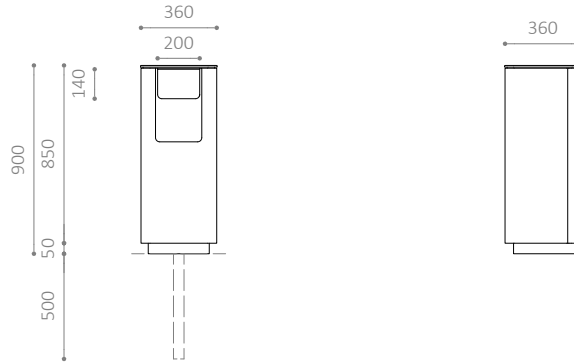
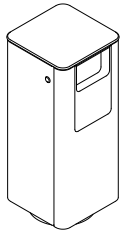

EGEDAL 2 80L

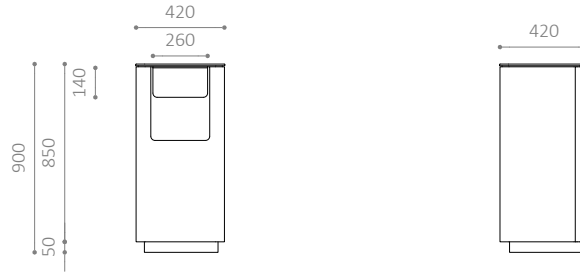
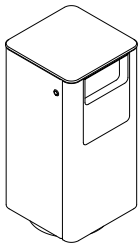

EGEDAL 2 105L

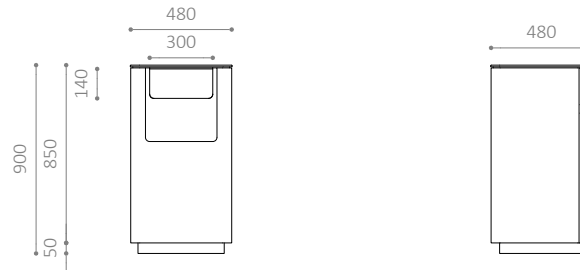
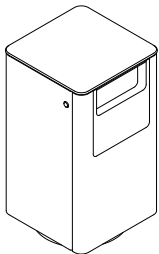

EGEDAL 2 LITTER BIN

- 40, 80 or 105 litres
- Single or double side opening
- Casing available smooth or with cut-out in your own design
- Front panel provides space for waste-sorting pictograms
- 80 litres model available as EGEDAL MILJØ (modular bins for multiple waste fractions)
- Side-hinged hatch with bag holder for easy emptying
- Also available in any RAL colour
- Opens with a triangular key – locks automatically when closed
- Can be equipped with a sensor to measure fill level

MATERIALS:

- Hot-dip galvanised steel
- Also available in powder-coated, hot-dip galvanised steel

DIMENSIONS:

Hatch/casing: 3 mm steel plate

Top: 8 mm steel plate

Front panel: 2 mm steel plate

Base 40/80/105 litres: Ø 290/Ø 350/Ø 410 mm tubular steel

INSTALLATION:

- Can be cemented in or bolted to the ground
- Recommended base dimensions: Ø 400 x 500 mm
- Distance from ground to top edge: 900 mm

EGEDAL 1

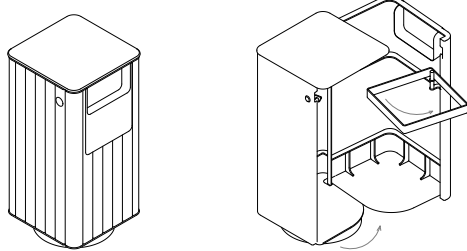

EGEDAL 1 40L

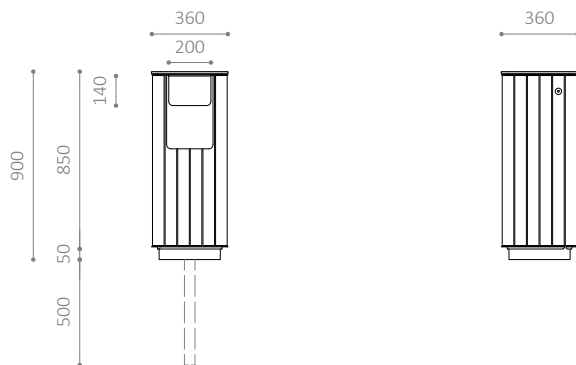
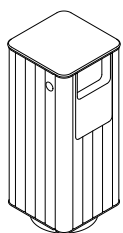

EGEDAL 1 80L

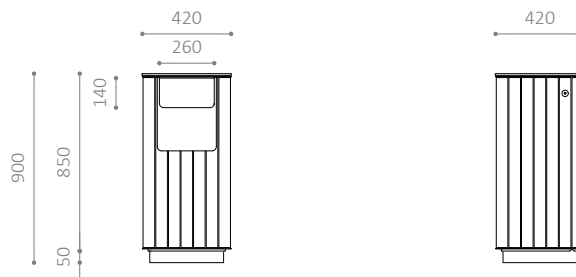
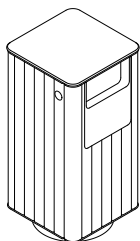

EGEDAL 1 105L

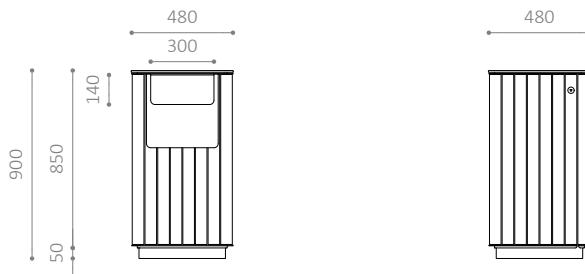
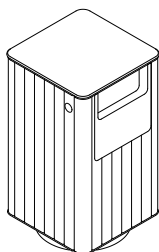

EGEDAL 1 LITTER BIN

- 40, 80 or 105 litres
- Single or double side opening
- Front panel provides space for waste-sorting pictograms
- 80 litres model available as EGEDAL MILJØ (modular bins for multiple waste fractions)
- Casing and hatch with wooden slats
- Side-hinged hatch with bag holder for easy emptying
- Also available in any RAL colour
- Opens with a triangular key – locks automatically when closed
- Can be equipped with a sensor to measure fill level

MATERIALS:

- Oil-treated, FSC®-certified mahogany
- Also available in untreated, FSC®-certified mahogany
- Hot-dip galvanised steel
- Also available in powder-coated, hot-dip galvanised steel

DIMENSIONS:

- Hatch/inner casing: 3 mm steel plate
- Top: 8 mm steel plate
- Front panel: 2 mm steel plate
- Cladding: 55 x 24 mm slats
- Base 40/80/105 litres: Ø 290/Ø 350/Ø 410 mm tubular steel

INSTALLATION:

- Can be cemented in or bolted to the ground
- Recommended base dimensions: Ø 400 x 500 mm
- Distance from ground to top edge: 900 mm

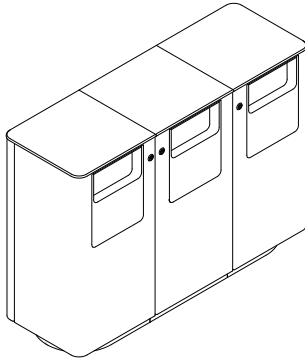

E 2x80L 840

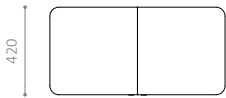

E 3x80L 1260

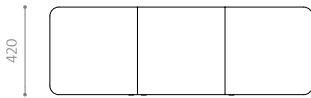

E 4x80L 1680

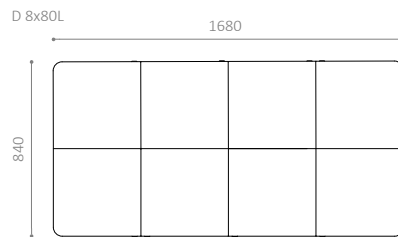
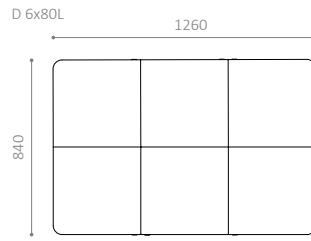
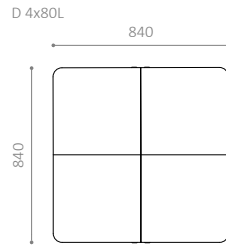
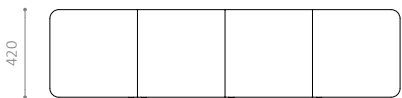

EGEDAL MILJØ 2 LITTER BIN

- 80 litres model as modular bin for multiple waste fractions
- Single or double side opening
- Casing available smooth or with cut-out in your own design
- Front panel provides space for waste-sorting pictograms
- Side-hinged hatch with bag holder for easy emptying
- Also available in any RAL colour
- Opens with a triangular key – locks automatically when closed
- Can be equipped with a sensor to measure fill level

MATERIALS:

- Hot-dip galvanised steel
- Also available in powder-coated, hot-dip galvanised steel

DIMENSIONS:

- Hatch/casing: 3 mm steel plate
- Top: 8 mm steel plate
- Front panel: 2 mm steel plate

INSTALLATION:

- Can be cemented in or bolted to the ground
- Recommended base dimensions: Ø 400 x 500 mm
- Distance from ground to top edge: 900 mm

Contact HITSA for more information.

EGEDAL MILJØ 1

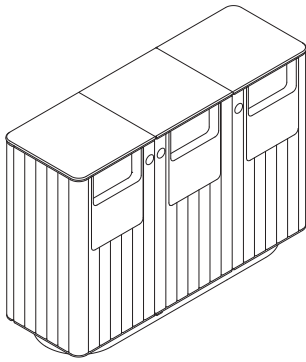

E 2x80L 840

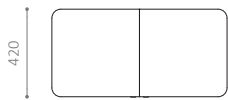

E 3x80L 1260

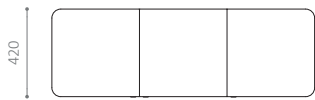

E 4x80L 1680

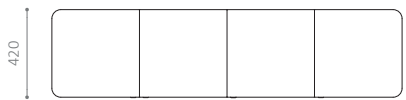

D 4x80L 840

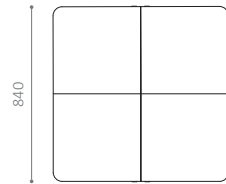

D 6x80L 1260

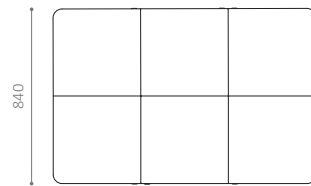

D 8x80L 1680

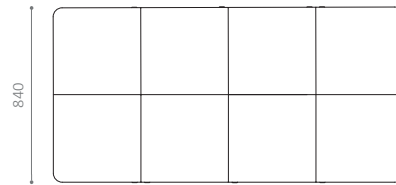

EGEDAL MILJØ 1 LITTER BIN

- 80 litres model as modular bin for multiple waste fractions
- Single or double side opening
- Front panel provides space for waste-sorting pictograms
- Casing and hatch with wooden slats
- Side-hinged hatch with bag holder for easy emptying
- Also available in any RAL colour
- Opens with a triangular key – locks automatically when closed
- Can be equipped with a sensor to measure fill level

MATERIALS:

- Oil-treated, FSC®-certified mahogany
- Also available in untreated, FSC®-certified mahogany
- Hot-dip galvanised steel
- Also available in powder-coated, hot-dip galvanised steel

DIMENSIONS:

Hatch/inner casing: 3 mm steel plate
Top: 8 mm steel plate
Front panel: 2 mm steel plate
Cladding: 55 x 24 mm slats

INSTALLATION:

- Can be cemented in or bolted to the ground
- Recommended base dimensions: Ø 400 x 500 mm
- Distance from ground to top edge: 900 mm

Contact HITSÅ for more information.